



NeoCool Circulator

Model

CF301

Instruction Manual

- Second Edition -

- Thank you for choosing the CF301 NeoCool circulator from Yamato Scientific Co., Ltd.
- For proper equipment operation, please read this instruction manual thoroughly before use. Always keep equipment documentation safe and close at hand for convenient future reference.

⚠ Warning:

Read instruction manual warnings and cautions carefully and completely before proceeding.

**Yamato Scientific America Inc.
Santa Clara, CA**

.

Contents

1. SAFETY PRECAUTIONS.....	1
• Explanation of Safety Symbols	1
• Symbol Glossary	2
• Warnings & Cautions	3
2. PRE-OPERATION PROCEDURES	5
• Installation Precautions.....	5
• Installation Procedure	10
3. COMPONENT NAMES & FUNCTIONS	12
• Main Unit Overview.....	12
• Control Panel.....	13
4. OPERATION PROCEDURE.....	14
• Main Operation	14
• Cooling Curves (Reference Data)	15
• Flow Rate/Lift Curves (Reference Data)	16
• Choosing Coolant for Low-Temp Applications (Reference Data)	17
5. HANDLING PRECAUTIONS.....	18
6. INSPECTION & MAINTENANCE	20
7. STORAGE & DISPOSAL	22
• Extended Storage / Unit Disposal	22
• Disposal Considerations	22
8. TROUBLESHOOTING	23
9. SERVICE & REPAIR	24
10. SPECIFICATIONS.....	25
11. WIRING DIAGRAM	26
• CF301 Wiring Diagram	26
• Replacement Items.....	26
12. LIST OF HAZARDOUS SUBSTANCES	27

1. SAFETY PRECAUTIONS

Explanation of Safety Symbols

A Word Regarding Symbols

Various symbols are provided throughout this text and on equipment to ensure safe operation. Failure to comprehend the operational hazards and risks associated with these symbols may lead to adverse results as explained below. Become thoroughly familiar with all symbols and their meanings by carefully reading the following text regarding symbols before proceeding.

 **Warning** Signifies a situation which may result in serious injury or death (Note 1)

 **Caution** Signifies a situation which may result in minor injury (Note 2) and/or property damage (Note 3)

(Note 1) Serious injury is defined as bodily wounds, electrocution, bone breaks/fractures or poisoning, which may cause debilitation requiring extended hospitalization and/or outpatient treatment.

(Note 2) Minor injury is defined as bodily wounds or electrocution, which will not require extended hospitalization or outpatient treatment.

(Note 3) Property damage is defined as damage to facilities, equipment, buildings or other property. (Note 1) Serious injury is defined as bodily wounds,

Symbol Meanings



Signifies warning or caution.
Specific explanation will follow symbol.



Signifies restriction.
Specific restrictions will follow symbol.



Signifies an action or actions which operator must undertake.
Specific instructions will follow symbol.

1. SAFETY PRECAUTIONS

Symbol Glossary

Warning



General Warning

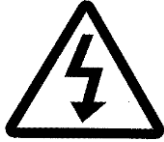

Danger!: High Voltage



Danger!: Extremely Hot



Danger!: Moving Parts



Danger!: Blast Hazard

Caution



General Caution



Caution: Shock Hazard!



Caution: Burn Hazard!



Caution: Do Not Heat Without Water!



Caution: May Leak Water!



Caution: Water Only



Caution: Toxic Chemicals

Restriction



General Restriction



No Open Flame



Do Not Disassemble



Do Not Touch

Action



General Action Required

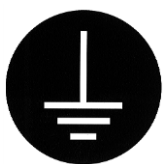

Connect Ground Wire



Level Installation Required

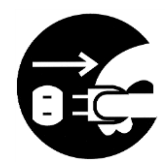

Disconnect Power



Inspect Regularly

1. SAFETY PRECAUTIONS

Warnings & Cautions

WARNING!

Never operate equipment near combustible gases/fumes.

Do not install or operate CF301 unit near flammable or explosive gases/fumes. Unit is NOT fire or blast resistant. Negligent use could cause a fire/explosion. See "List of Hazardous Substances" (P.27).

Always ground equipment.

Always ground this unit properly to avoid electric shock.

DO NOT operate equipment when abnormalities are detected.

If smoke or unusual odors begin emitting from unit, or if any other abnormalities are detected, terminate operation immediately, turn off main power switch (Earth Leakage Breaker - "ELB") and disconnect power cable. Continued operation under such conditions may result in fire or electric shock.

DO NOT operate with bundled or tangled power cable.

Operating unit with the power cable bundled or otherwise tangled, may cause power cable to overheat and/or catch fire.

DO NOT damage power cable.

Damaging the power cable by forcibly bending, pulling or twisting may cause fire or electric shock to the operator.

DO NOT handle flammable substances without proper ventilation.

Be sure there is adequate ventilation when working with certain flammable substances (such as ethanol, etc.), which evaporate quickly at or below room temperature, and emit flammable fumes. Insufficient ventilation may cause a fire or explosion. See "List of Hazardous Substances" (P.27).

NEVER disassemble or modify equipment.

Attempting to dismantle or modify unit in any way, may cause malfunction, fire or electric shock.

Keep upright.

Never tip or place unit on its side while moving or transporting. Damage to refrigeration system may result. If briefly tilting unit to one side or the other is unavoidable during transport, refrain from turning power on for at least 24 hours after positioning unit upright.

1. SAFETY PRECAUTIONS

Warnings & Cautions

CAUTION!

 **DO NOT operate equipment during thunderstorms.**

In the event of a thunderstorm, terminate operation and turn off main power switch (ELB) immediately. A direct lightning strike may cause damage to equipment, or result in fire or electric shock.

 **DO NOT touch coolant.**

CF301 chillers are designed to maintain coolant fluid at temperatures below freezing. Touching or handling coolant in the fill reservoir with bare hands or fingers may result in severe frostbite. Do not touch!

 **DO NOT touch condenser fins.**

Edges of condenser fins are very sharp. Do not contact with bare hands or skin. Laceration injuries may result.

2. PRE-OPERATION PROCEDURES

Installation Precautions

WARNING!

1. Ground wire **MUST** be connected properly.



- Ground wire must be connected to a proper grounding line or terminal in order to prevent electric shock.
- Never connect ground wire to gas lines or water pipes.
- Never connect ground wire to telephone grounding lines or to lightning conductor rods. Doing so may result in fire or electrical shock.
- Never insert multiple plugs into a single outlet. Doing so may result in power cable overheating, fire or drop in voltage.

Connect to grounded outlet

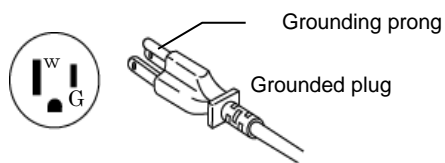

Outlet with ground receptacle

When no ground terminal is found:

- Grounding to Electrical Equipment Technical Standards, Section 19, class D (Grounding Resistance Max. 100Ω) is required in Japan. Contact a local dealer, electrician, or Yamato Sales office for location-specific electrical requirements.

Use ground adapter for ungrounded outlets

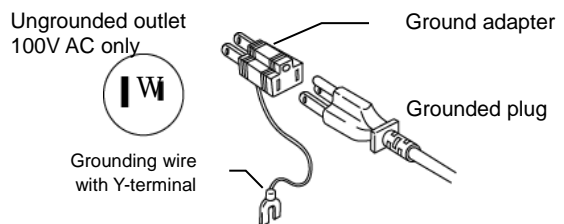

Outlet with no ground receptacle

Ground adapter

- Insert grounded plug into ground adapter. Connect grounding wire (green) from ground adapter to a ground terminal.

2. Place appropriately.



- Do not place CF301 unit:
 - where flammable or corrosive gases/fumes will be generated.
 - where external temperature will exceed 35°C, will fall below 5°C or will fluctuate.
 - in excessively humid or dusty locations.
 - where there is constant vibration.
 - where power supply is erratic.
 - in direct sunlight or outdoors



- Place CF301 in a location with sufficient space, and ventilation as specified as below.

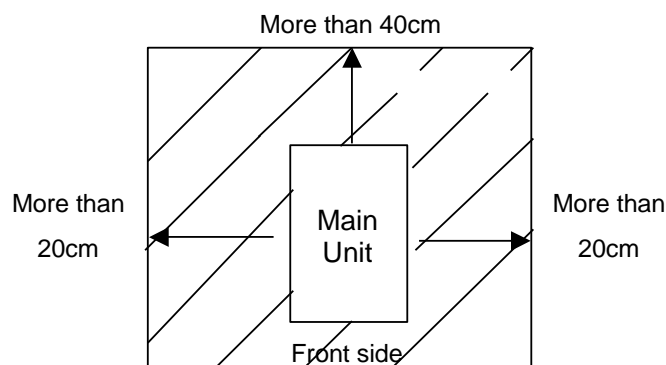

2. PRE-OPERATION PROCEDURES

Installation Precautions

3. Place in a location free of flammables and explosives.



- Never place or operate near flammables or explosives. BE units are NOT fire or blast resistant. Simply switching the main power switch (ELB) "ON" or "OFF" can produce a spark, which could relay during operation, causing a fire or explosion when near flammable or explosive fluids, chemicals or gases/fumes. See "List of Hazardous Substances" (P.27).

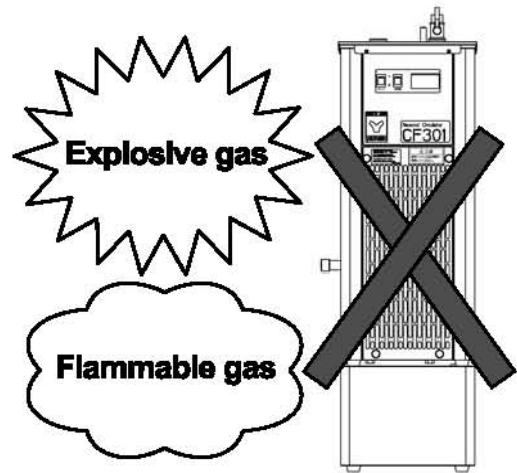

4. DO NOT disassemble or modify.



- Attempting to disassemble or modify this unit in any way may result in malfunction, fire or electric shock.

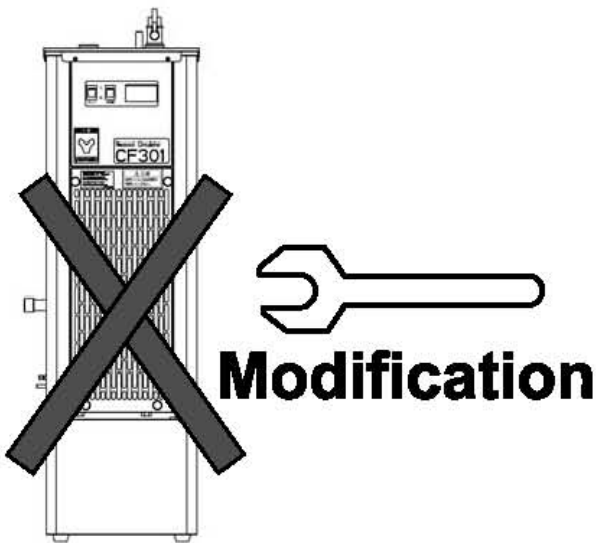

5. Place on a level surface.



- Place unit on a level and even surface. Failure to do so may result in abnormal vibrations or noise and damage to the refrigeration system.

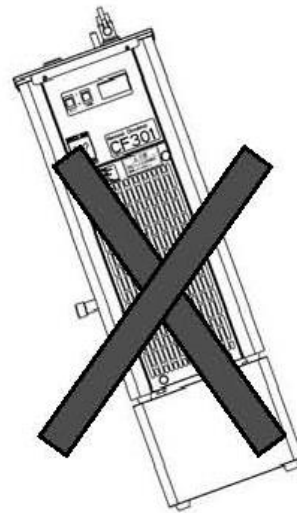

Approximate unit weight: 38Kg
Handle with care. Transportation and installation should always be performed by two or more people.

2. PRE-OPERATION PROCEDURES

Installation Precautions

6. Place in a dry location.



Place unit where it will be free from liquid spray and other moisture. Failure to do so may result in control mechanisms becoming wet, causing malfunction, electrical shock and/or fire.

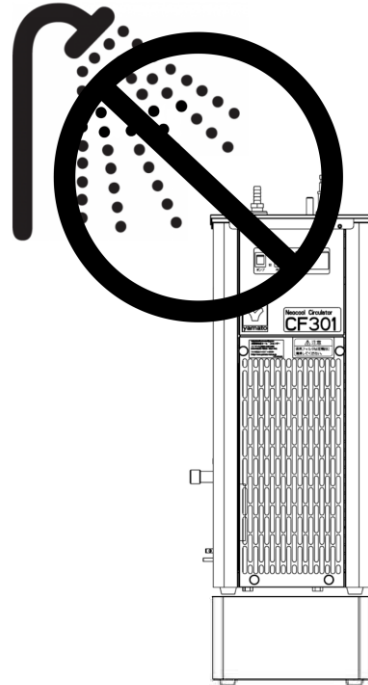

CAUTION!

7. Connect to a properly rated power supply.



- Connect power cable to a suitable facility outlet or terminal, according to the following electrical requirements.

Power requirements: CF301: 115V AC, 50/60Hz, 5.6A

NOTE)

Check the line voltage on outlet or terminal to be used and properly evaluate whether to utilize a line being shared by other equipment. If the unit is not activated by turning on the main power switch (ELB), take an appropriate course of action, such as connecting the unit to a dedicated power source.

If multiple power cables are connected to a single outlet, input voltage to unit may drop, causing degraded cooling and temperature control performance.

8. Install in a safe, well-ventilated area.



- In the event of an earthquake or other unforeseen incident, equipment may unexpectedly shift or fall, causing injury. Taking preventative steps to install unit in a safe location, away from room access doors and out of harm's way is strongly recommended.
- Install unit so that side panel heat vents (see "Main Unit Overview" on P.12 for location) are unobstructed and allowed to sufficiently diffuse heat. Failure to do so may result in excessive temperatures inside the unit control panel, causing possible degraded CPU board performance, malfunction or fire. See installation specifications on P.5 above.

2. PRE-OPERATION PROCEDURES

Installation Precautions

9. Handle power cable with care.

- ⊘ Never operate unit with power cable bundled or tangled; and do not modify, bend, forcibly twist or pull on power cable. Doing so may cause fire and/or electrical shock.
- Do not risk damage to power cable by positioning it under desks or chairs, or having it pinched between objects. Doing so may cause fire and/or electrical shock.
- Do not place power cable near kerosene/electric heaters or other heat-generating devices. Doing so may cause power cable insulation to overheat, melt and/or catch fire, which may result in electric shock.
- ⚠ Turn off main power switch (ELB) immediately and disconnect from facility terminal or outlet, if power cable becomes partially severed or damaged in any way. Failure to do so may result in fire or electric shock. Contact a local dealer or Yamato sales office for information about replacing power cable if it is damaged.
- Always connect power cable to appropriate facility outlet or terminal.

10. Coolant hose connections.

- ⚠ When connecting to an external target device, secure all hose connections adequately to prevent leaks.
- Closing the circulation path with a solenoid valve or throttle valve may cause pump to malfunction and leak, if it is left closed.
- Always keep outlet stop valve open when pump is in operation.
- Do not excessively restrict flow. Keep flow maintained at 10% over maximum flow rate (see "Specifications" on P.25), as a general rule.
- In the event that external target device is equipped with a solenoid valve, or if circulation flow is less than 10% of maximum pump flow rate, place a bypass circuit in the circulation path between the two units (see illustration to the right).

CF301

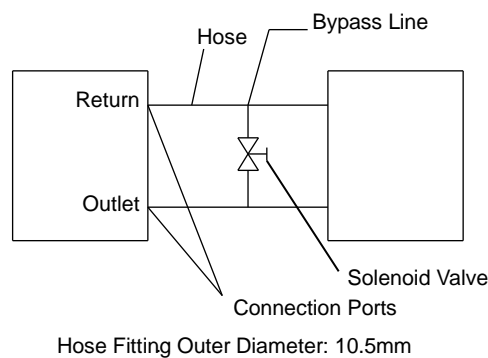

2. PRE-OPERATION PROCEDURES

Installation Precautions

11. Select coolant based on operating temperature.



- Choose a coolant fluid relative to working temperature.

If objective temperature is more than 10°C, use tap water or softened tap water

If objective temperature is less than 10°C, use an antifreeze solution, such as Naiburain.

⌘ DO NOT use purified and/or deionized water as coolant.

The ready-to-use Raku-raku line of Naiburain solutions from Yamato Scientific is recommended.

Contact a local dealer or Yamato sales office to purchase Raku-raku Naiburain solutions.

Name	Product Code	Concentration (Wt%)	Min. STD Temperature	Container Size (in liters)
Raku-raku Solution: Z16005	756071	60%	-20°C	5L
Raku-raku Solution: Z16010	756072			10L
Raku-raku Solution: Z10005	756073	100%	-30°C	5L
Raku-raku Solution: Z10010	756074			10L
Raku-raku Solution: NFP6005	756075	60%	-10°C	5L
Raku-raku Solution: NFP6010	756076			10L

Observe the following in order to prevent malfunction and personal injury:

- Coolant concentration may become decreased after several months of use.
Check anti-freeze concentration or change coolant entirely approximately every 6 (six) months.
- If only tap water is being employed as coolant, change entirely approximately every 3 (three) months.
- Do not use well water, purified water or deionized water as coolant.
- Degraded unit performance and/or pump overload may be caused by using heavy or viscous coolants, such as Fluorinert (by 3M), GALDEN (by Daitoku Tech), etc.
- Never use the following substances in CF unit.
 - 1) Corrosive chemicals
 - 2) Solutions which become corrosive when heated, such as Fluorinert (by 3M), etc.
 - 3) Solutions which emit harmful fumes, such as methanol

If an antiseptic agent is to be used, confirm material constitution of components with which fluid will be in contact and whether it will harm these components, before selecting.

(Major fluid contact component composition: Stainless Steel, Copper w/nickel plating, Silicon Rubber)

- Assure sufficient ventilation when ethanol or other highly flammable fluids are used as anti-freeze coolants. Never operate unit near open flame or other ignition sources (static electricity, etc.).

2. PRE-OPERATION PROCEDURES

Installation Procedure

1. Move unit into position.

- CF301 models have rubber feet. Be sure to place unit where all four feet come into contact with the floor.

2. Check drain/overflow caps.

- Check to make sure that drain and overflow ports are capped.

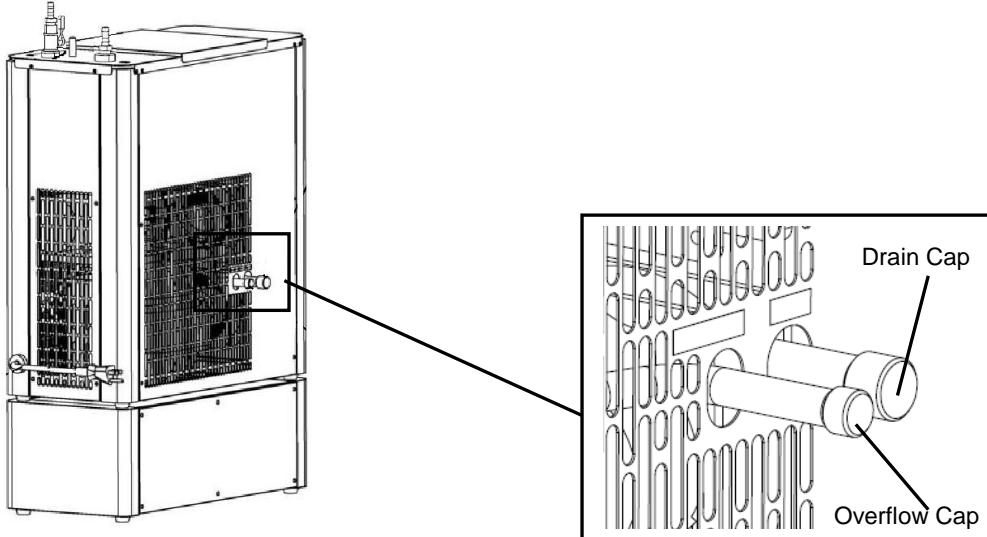

3. Connect hoses.

- CF301 units are an external closed loop circulation system. Make all connections free of coolant leaks and be sure to connect outlet (OUT) and return (IN) properly. Hose fittings are not included. Purchase appropriate fitting options separately. (fitting valve outer diameter is Rc3/8)

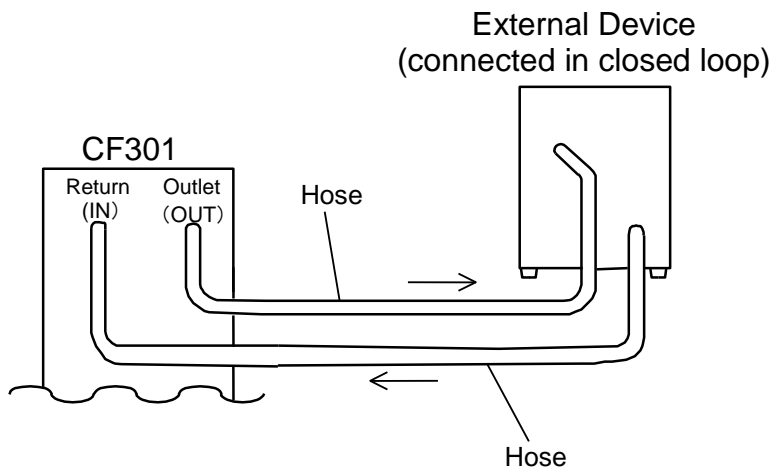

4. Circulation line precautions.

- Be sure to confirm flow direction and make connections accordingly.
 - Be sure that circulation lines are the minimum required lengths. Flow resistance increases, while cooling efficiency is decreased in relation to longer circulation line length. See reference data on P.16 and specifications on P.25 for pump capacity.
 - Be sure to use proper hoses in circulation lines. DO NOT connect circulation lines to gas or water plumbing lines.
 - Be sure that intended external circulation device conforms to proper circulation flow and pressure levels. Otherwise equipment damage, malfunction or other mishap may result.
- ⚠ DO NOT connect CF301 unit to external devices with supplemental powering mechanisms which affect coolant flow or circulation.

2. PRE-OPERATION PROCEDURES

Installation Procedure

5. Connect power cable.

- Be sure power switch, refrigeration switch and pump switch are turned "OFF", then plug power cable into outlet.

6. Select coolant.

- Refer to reference data on P.17.

7. Add coolant.

- Remove reservoir cover and add coolant until cooling coil is entirely immersed and level reaches indication arrow. When adding coolant, be sure to remove the overflow cap from the left side of unit and place an appropriate basin beneath overflow outlet.

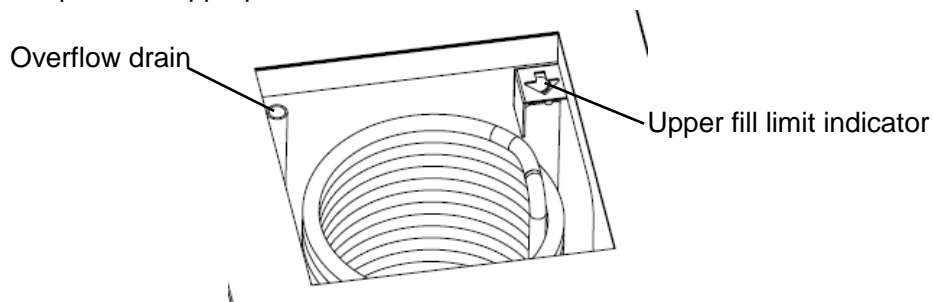

- Turn on power and pump switch to begin circulating coolant. Confirm that fluid circulates normally. Coolant level in reservoir will decrease as coolant circulates to external device. Add coolant as needed.
- When coolant is restored to proper level, turn OFF power switch.

8. Replace reservoir cover.

3. COMPONENT NAMES & FUNCTIONS

Main Unit Overview

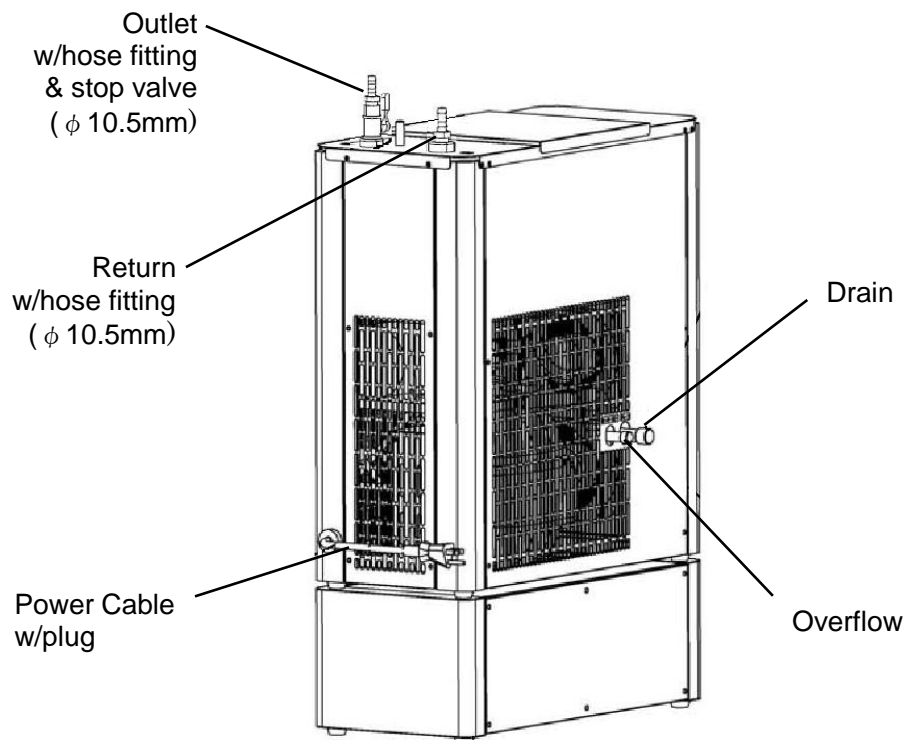
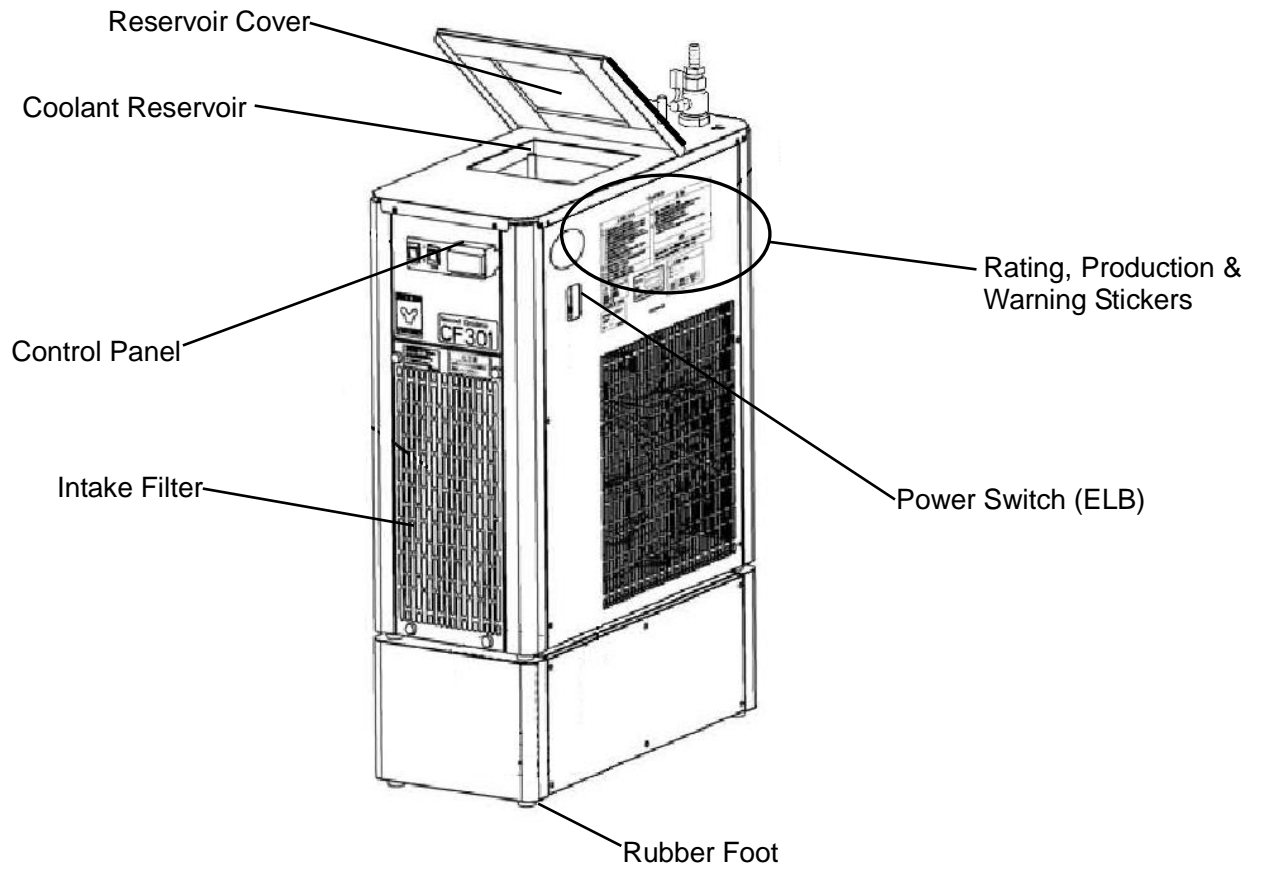

3. COMPONENT NAMES & FUNCTIONS

Control Panel

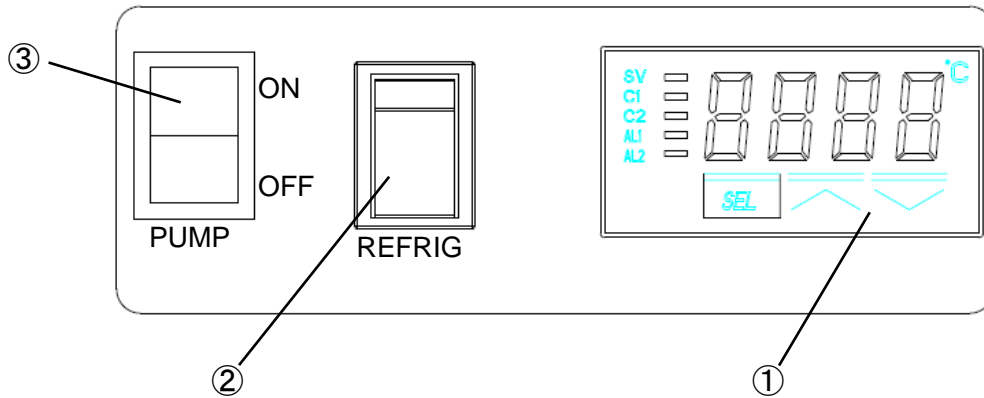

Item	Function
① Temperature controller	Control temperature of coolant reservoir with SEL key and up/down arrow keys. (Range: -20 to 30°C)
② Refrigeration switch	Turns refrigeration system ON/OFF.
③ Pump switch	Turns circulation pump ON/OFF.

4. OPERATION PROCEDURE

Main Operation

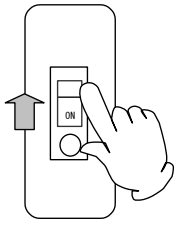
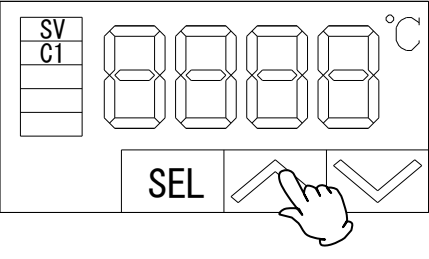
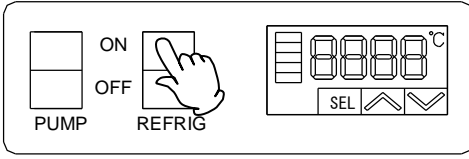
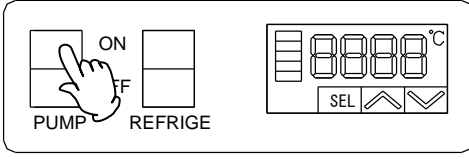
<p>1. Turn "ON" main power switch (ELB).</p>	
<p>2. Set temperature. Press "SEL". The SV indication lamp illuminates. Set desired temperature using "▲▼". Press "SEL" once again after temperature has been set and confirmed.</p>	
<p>3. Turn on refrigeration system. After confirming that C1 indicator lamp (control output 1) is illuminated, turn the refrigeration switch ON. Unit begins operation approximately 3 minutes, 30 seconds from moment refrigeration switch is turned ON. This delay is NOT a malfunction/failure. ⚠ There may be a slight time lag in relation to C1 lamp on/off and refrigeration system activation/deactivation.</p>	
<p>4. Turn on circulation pump. After confirming connections are secure and reservoir is filled to the proper level, turn the pump switch ON. ⚠ Be sure the stop valve on the outlet fitting is open when the pump is turned on.</p>	
<p>5. End operation. Turn off pump, refrigeration switch, and main power switch.</p>	

4. OPERATION PROCEDURE

Cooling Curves (Reference Data)



The following graphs show cooling capacity and characteristics. Findings may vary with external device, external temperature, etc. Use graph values as reference only.

Analysis provisions (cooling capacity, cooling characteristics)

- Room temperature: 23°C, external load: none, power supply: 100V AC
- CPM: 50Hz (cooling capacity/characteristics), 50/60Hz (flow rate/lift)
- Coolant: 60% solution of ethylene glycol (cooling capacity/characteristics), tap water (flow rate/lift)
- Coolant quantity: 3L

⌘ Lift conversion: 1.0MPa \approx 10kg/cm² = 100.0m

Cooling Capacity

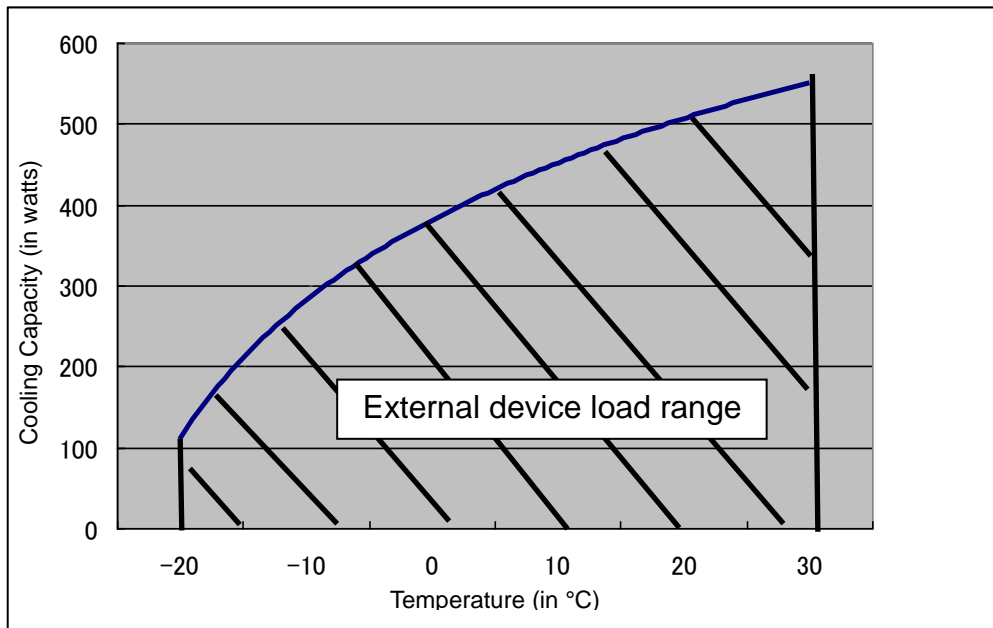

Cooling Characteristics

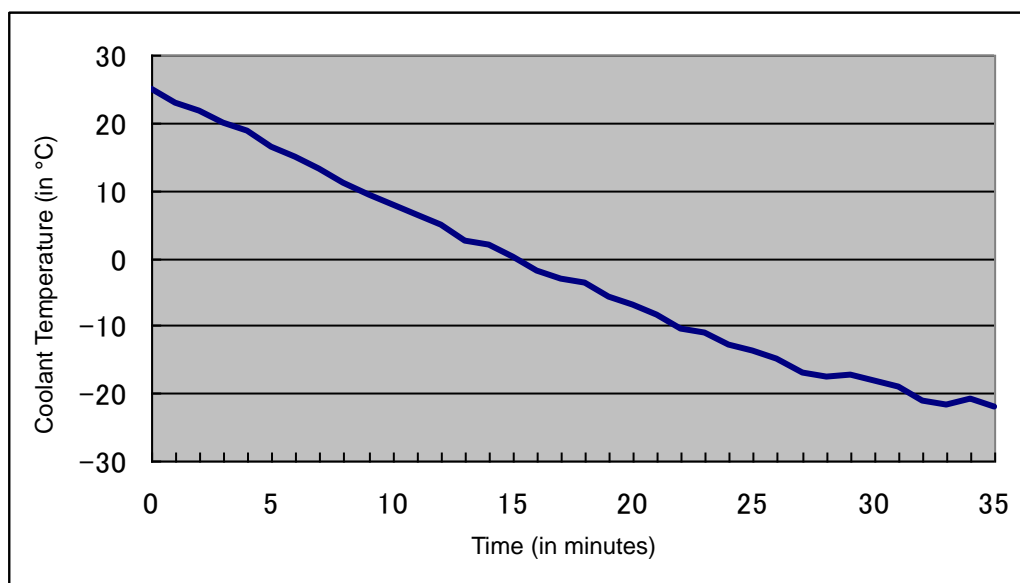

4. OPERATION PROCEDURE

Flow Rate/Lift Curves (Reference Data)

Flow Rate vs. Lift curve (based on hose fitting size of $\Phi 10.5\text{mm}$)

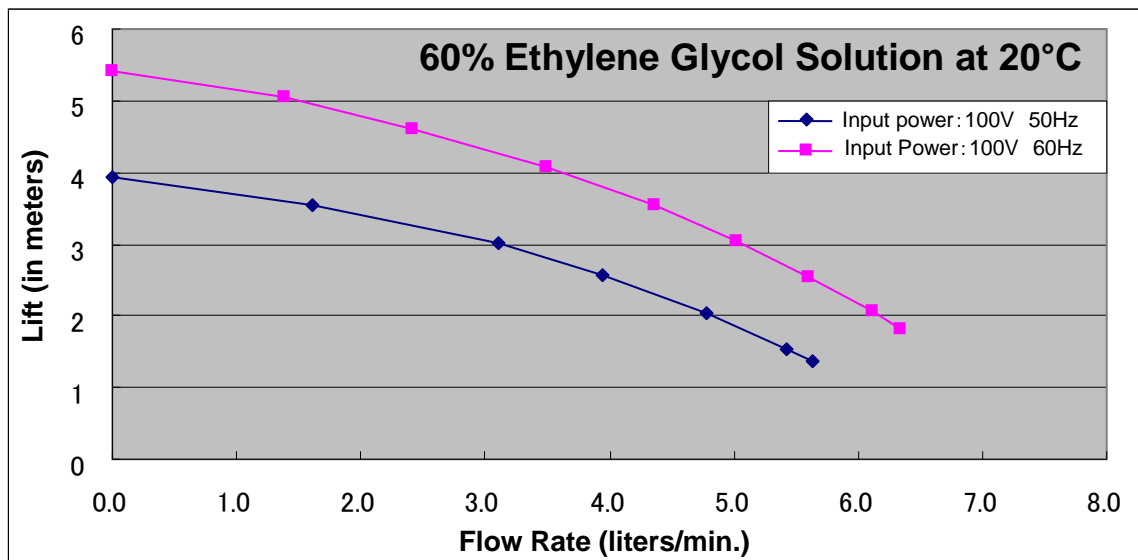
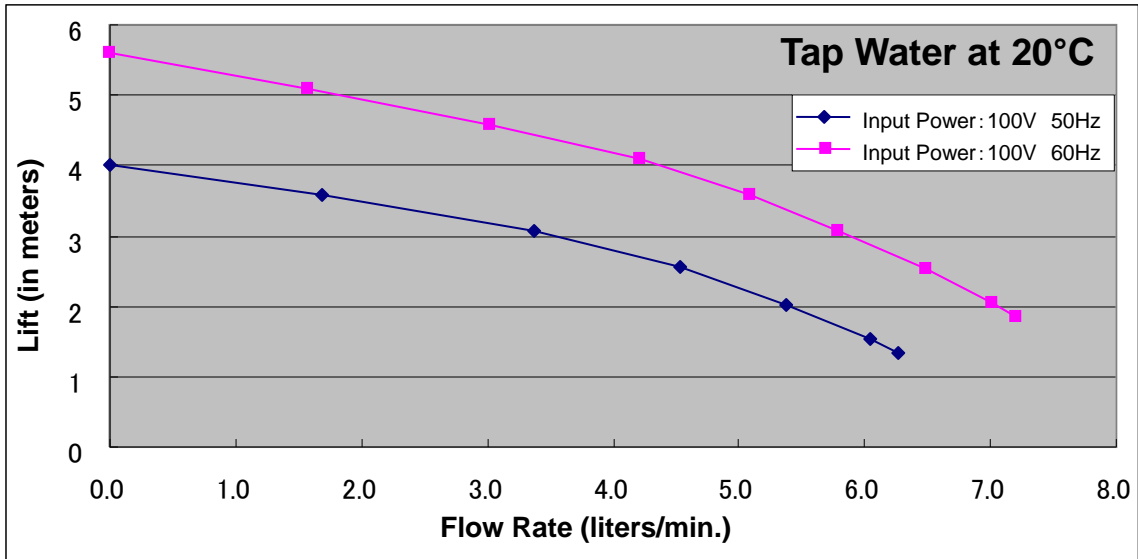

4. OPERATION PROCEDURE

Choosing Coolant for Low-Temp Applications (Reference Data)

An anti-freeze coolant solution is required for applications below 10°C. Naiburain® products are recommended. Select concentration based on working temperatures below 10°C. See “Handling Precautions” on P.18.

Ethylene Glycol

Characteristics	
Boiling Point	197.8°C
Freezing Point	-13.0°C
Flash Point	121.0°C
Ignition Point	410.0°C
Specific Gravity (at 20°C)	1.1188
Specific Heat (at 20°C)	0.561cal/g · °C
Latent Heat of Evaporation	191cal/g · °C
Viscosity	0.021Pa · s (20.93CP)
Steam Pressure (at 25°C)	16.0Pa (0.12mHg)

Ethanol (Warning: LOW FLASH POINT!)

Characteristics	
Molecular Weight	46.068
Boiling Point	78.32°C
Freezing Point	-114.5°C
Flash Point	13°C (enclosed), 18°C (unenclosed) 24.7°C (60% solution at 25°C)
Ignition Point	439°C
Specific Gravity (at 20°C)	0.7893
Specific Heat (at 20°C)	0.579cal/g · °C
Viscosity	1.0826cp (at 25°C)

Naiburain®

Product Name	Z1, Z1-K		RH		NFP	
	50Wt%	100 Wt%	50Wt%	100 Wt%	50Wt%	100 Wt%
Boiling Point (in °C)	104	117	105	118	102	107
Specific Resistance (in Ω · cm at 25°C)	625	1250	270	440	530	970
Conductivity (in S · m ⁻¹ at 25°C)	0.160	0.080	0.370	0.227	0.189	0.103
Steam Pressure (KPa at 20°C)	1.7	0.5	1.7	0.5	2.3	1.3
Freezing Point (°C)	-21	Below -50	-21	Below -50	-13.5	Below -50
Specific Gravity (at 20°C)	1.05	1.10	1.07	1.134	1.026	1.048
Viscosity (mPa · s at 20°C)	2.5	9.5	2.5	9.5	2.6	9.4
Specific Heat (cal/g at 20°C)	0.850	0.670	0.850	0.670	0.773	0.642

Ethylene Glycol Freezing Points

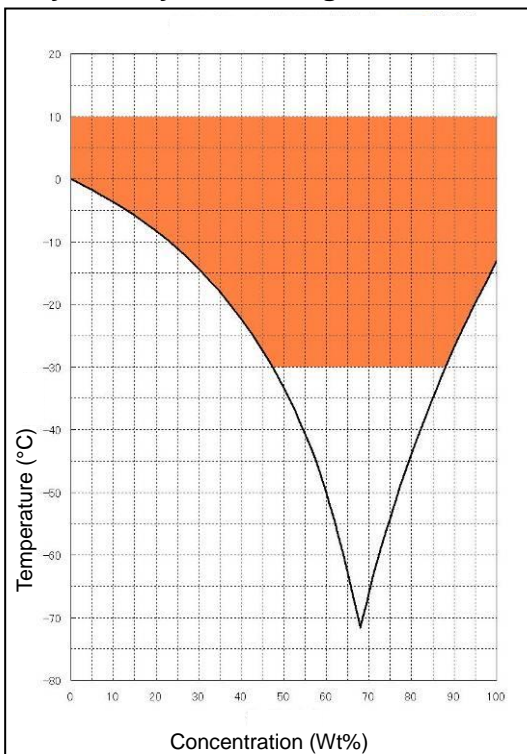

Naiburain® Freezing Points

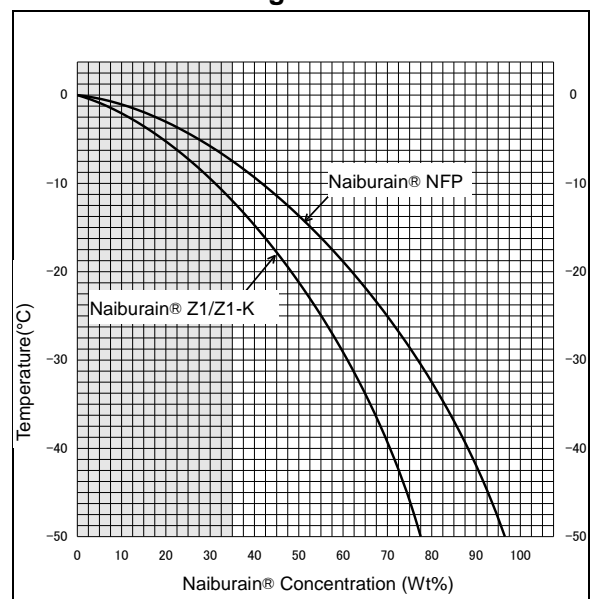

5. HANDLING PRECAUTIONS

WARNING!

DO NOT operate equipment when abnormalities are detected.

-  If unit begins emitting smoke or abnormal odors for reasons unknown, turn off main power (ELB) immediately, disconnect power cable from power supply, and contact a local dealer or Yamato sales office for assistance. Continued use without addressing abnormalities may cause fire or electric shock, resulting in serious injury or death. Never attempt to disassemble or repair unit. Repairs should always be performed by a certified technician.

DO NOT handle flammable substances without proper ventilation.

-  Be sure there is adequate ventilation when working with certain flammable substances (such as ethanol, etc.), which evaporate quickly at or below room temperature, and emit flammable fumes. Little or no ventilation may cause a fire or explosion resulting in serious injury or death. Refer to "List of Hazardous Substances" (P.27).

CAUTION!

Reservoir capacity.

-  CF301 coolant reservoir capacity is approximately 3 liters. Unit may overflow if reservoir is filled beyond capacity or fill indicator.

DO NOT climb on equipment.

-  Do not attempt to climb onto unit or substitute it for a proper step ladder. Units are not designed to support bodily weight and damage may result. In addition, unit may become unstable and tip over or fall resulting in equipment damage, serious injury or death.

DO NOT place objects on equipment.

-  Do not place any objects on unit. Doing so may cause unit to become unstable and tip over, resulting in possible equipment damage, injury or death.

Wash coolant reservoir before use.

-  Although CF units are cleaned thoroughly before shipping from Yamato's manufacturing facility, washing out the reservoir once again before use is recommended to eliminate any debris or contaminants accumulated during shipping.



DO NOT operate equipment during thunderstorms.

-  In the event of a thunderstorm, turn off main power switch (ELB), and disconnect power cable immediately. A direct lightning strike may cause equipment damage fire or electric shock, resulting in serious injury or death.

Overnight and extended storage.

-  Whenever unit is not in operation, left standing overnight or placed in storage, always turn off main power switch and disconnect power cable. Drain coolant from reservoir and lines if unit is to be put in storage.

Circulation pump.

-  • Never operate the circulation pump dry (without fluid in reservoir). Damage or malfunction may result.
- Keep coolant reservoir covered and do not allow any debris to enter and remain in reservoir. Damage to pump may result.
-  • If solenoid valve and throttle are in the circulation path, do not leave valve closed or apply too much throttle. Damage to pump may result.
- Keep coolant flow rate at 10% over maximum flow specification. See P.25.

5. HANDLING PRECAUTIONS

Power failures.



In the event of a power failure, unit automatically returns to point of operation where power loss occurred and continues operating from that point when power is restored. If automatic restore feature is not desired after power is restored, turn main power switch OFF.

Refrigeration system ON delay timer.



CF301 units feature an ON delay timer which delays pump startup for approximately 3 minutes, 30 seconds. This feature extends pump life and safeguards pump from:

1. Under-lubrication at startup
2. Abrupt power surges at startup
3. Overloading at startup
4. Motor coil burnout from excessive wear and tear

Thermal protection switch.



To keep circulation pump from overheating and burning out, CF301 units feature a thermal protection switch which trips and cuts power to circulation pump when motor temperature becomes excessive. Pump automatically restarts after sufficiently cooling down.

Frost deposits.



Frost may form around unit outlet and return ports depending on operation and external temperature proportion. When this occurs, frost deposits may be wiped away with a dry cloth.

Hose replacement.



Replacing silicone hoses approximately once every two years or when hoses become discolored is recommended. Contact a local dealer or Yamato sales office for replacements.

Changing coolants.



When changing to a different type of coolant, be sure to drain previous coolant from reservoir and lines completely before adding new coolant.

6. INSPECTION & MAINTENANCE

WARNING!

- Turn off ELB and disconnect power cable before conducting inspection and maintenance, unless otherwise necessary.
- Inspect and perform maintenance on unit when coolant in reservoir is at room temperature.
- Do not attempt to disassemble unit.
- Do not touch the condenser fins with bare hands or fingers.

CAUTION!

- Clean unit using a soft, damp cloth.
- Never use benzene, paint thinner, scouring powder, scrubbing brush or other abrasives and solvents to clean unit. Superficial damage and/or discoloration, as well as deformity to some components may result.

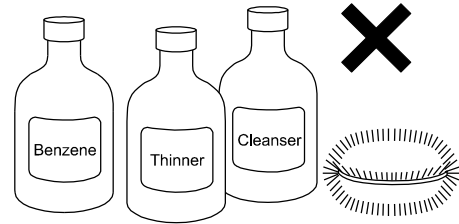

Monthly maintenance.

- Test main power switch (ELB) function.
 1. Connect power cable.
 2. Turn power switch ON.
 3. Depress the red test switch with a fine-point object, such as a ballpoint pen, etc.
 4. If power switch turns OFF without delay, it is functioning normally.

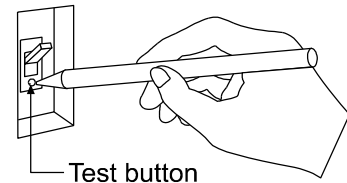

Clean filter & condenser fins regularly.

- A clogged intake filter and condenser fins will degrade cooling performance and may result in refrigeration system malfunction. Intake filter maintenance and cleaning intervals will vary depending on usage and operating environment. Be sure to clean filter and condenser fins periodically.
- ❖ Loosen the 4 mounting screws attaching intake cover and remove. Clean dust from condenser fins using a vacuum cleaner or other suction-type cleaning device.
- ❖ Remove filter from intake cover and wash or clean accumulated dust with a vacuum cleaner.
- ❖ Replace filter and re-install intake cover.

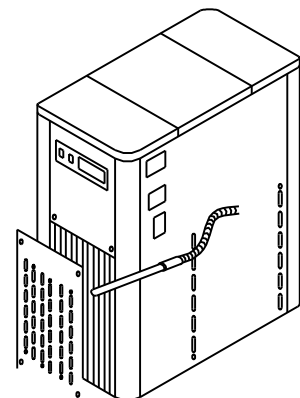

Be careful not to bend or crush condenser fins while cleaning.

6. INSPECTION & MAINTENANCE

Reservoir and coolant maintenance.

Remove any foreign substances and debris from coolant reservoir as frequently as possible. Circulation pump malfunction may result if allowed to remain.
Wear proper gloves when performing coolant and reservoir maintenance .

Hose insulation (sold separately) replacement.

Replace hose insulation material approximately once every 2 (two) years to keep unit in proper working order.
Call a local dealer or Yamato sales office for replacements.

Change coolant regularly.

Change coolant fluid entirely every 3 months for tap water/ethanol solutions or every 6 months for Naiburain® solutions.
Dust, hair, algae, mineral deposits and other substances may accumulate in circulation pump, if the above guidelines are not observed, resulting in decreased pump performance, malfunction or failure.

Contact a local dealer or Yamato sales office for further assistance.

7. STORAGE & DISPOSAL

Extended Storage / Unit Disposal

CAUTION!

Extended storage

To store or place unit out of service:

- Turn off power switch and disconnect power cable.
- Drain coolant.

WARNING!

Disposal

- CF301 units use a Freon alternative refrigerant. Observe the Freon Collection Act and request the assistance of a professional.
- Place out of reach of children.
- Dispose of as bulky or industrial waste.

Disposal Considerations

Dispose of or recycle this unit in a responsible and environmentally friendly manner.

Yamato Scientific Co., Ltd. strongly recommends disassembling unit, as far as is possible, in order to separate parts and recycle them in contribution to preserving the global environment.

Major components and materials, comprising CF301 units are listed in the table below:

Component	Composition
Main	
Casing	Galvanized steel paneling with baked-on melamine resin coating
Coolant reservoir	Stainless steel
Cover	Stainless steel, Resin
Production stickers	Polyester (PET) resin film
Corner bumpers	Alkylbenzenesulfid (ABS) resin
Rubber feet	Synthetic rubber
Electrical	
Switches, Relays	Resin composites, etc.
Power cable & wiring material	Synthetic rubber composites, copper, nickel, etc.
Fan motor	Aluminum, other synthetics
Pump	Iron alloys, copper, resin, ceramic, etc.
Refrigeration system	
Compressor	Iron alloys, copper, etc.
Condenser	Iron, copper, aluminum
Cooling mechanism	Nickel plated copper
Plumbing lines	Copper alloys, etc.
Coolant reservoir	
Drain, overflow and internal plumbing	Silicon rubber
Connection components	Resin
Hose insulation	Polyurethane sponge
Refrigerant	R404A Consult specialist for handling refrigerant.

8. TROUBLESHOOTING

Troubleshooting Table

Symptom	Possible Causes
Temperature controller light does not illuminate.	<ul style="list-style-type: none"> • Power cable is not properly connected to outlet. • Power failure in progress. • Main power switch (ELB) is turned "OFF"
Temperature does not fall.	<ul style="list-style-type: none"> • Condenser fins need cleaning. • Thermal capacity of coolant has been exceeded. • External temperature exceeds 35°C. • Intake or heat vents obstructed. • Power supply voltage has dropped below rating.
Refrigeration system will not restart.	<ul style="list-style-type: none"> • Refrigeration system is in overload. Turn off refrigeration switch immediately, see possible causes for "temperature does not fall", above, and turn on refrigeration system again after several minutes.
Coolant fluid does not circulate.	<ul style="list-style-type: none"> • Outlet stop valve is closed. • Circulation path is closed, restricted or otherwise obstructed. • Coolant fluid is too heavy or viscous.

Error Table

Error Sign	Cause	Remedy
UUUU	Sensor error	Check whether sensor is disconnected or severed.
FALR	Temperature controller malfunction	Terminate operation. Turn off power immediately, and call for service

If problems persist, turn off power, disconnect power cable and call for service.

Requests for Repair

When a problem occurs, terminate operation immediately, turn off main power switch (ELB) and disconnect power cable.

Contact a local dealer or Yamato sales office for assistance.

The following information is required for all repairs.

- Model name
- Serial Number
- Date (year/month/day) of purchase
- Description of problem in as much detail as possible

} See production/rating sticker on unit. Refer to P.12 for location.

Guaranteed Supply Period for Repair Parts

Guaranteed maximum supply period for repair parts is 7 (seven) years from date of discontinuation for CF301 NeoCool chillers. "Repair parts" is defined as components which, when installed, allow for continued unit operation.

10. SPECIFICATIONS

Model		CF301			
Circulation system		Closed-loop circulation			
Operational external temperature range		5 to 35°C			
Performance ⌘ 1	Temperature setting range		-20 to room temp		
	Refrigeration capacity ⌘ 2 (AC100V 50Hz) (kcal/h·W·liquid temp)		Approx. 450W (387kcal) at 10°C		
			Approx. 360W (309kcal) at 0°C		
			270W (232kcal) at -10°C		
	Pump (*)	Max. flow rate ⌘ 3		50Hz: Approx. 6.26L/min 60Hz: Approx. 7.21L/min (discharge pressure: 0kpa)	
Max. flow pressure ⌘ 3		50Hz: Approx. 40kpa 60Hz: Approx. 56kpa (flow rate: 0L/min)			
Lift range		4.0m/5.6m			
Configuration	Temperature control system		Refrigerator ON/OFF		
	Temperature sensor		T thermo couple (with SUS protection tube)		
	Temperature setting /display system		Digital setting/LED display		
	Refrigeration system		Air cooling, 450W		
	Refrigerant		R404a		
	Cooling coil		Nickel plated copper		
	External circulation nozzle		Outer diameter: 11mm (discharge and return) with hose fitting		
	Circulation pump		Magnetic pump 10/15W		
	Reservoir	Material		SUS304	
		Dimensions		151 × 151 × 177mm	ϕ 300×235mm ϕ 370×400mm
Capacity		Approx. 4L (Fluid capacity: 3L)			
Safety devices		Electric leakage breaker, Refrigeration overload relay maintenance circuit, Pump thermal protection switch, Refrigeration system ON delay timer			
Other functions		Overflow, Drain, Fluid level meter			
Standard Measurements	External dimensions ⌘ 4 (WxDxH mm)		228×508×756 (798.5)		
	Weight		Approx. 38Kg		
	Power supply ⌘ 5		115V AC, 50/60Hz, 5.6A (15A)		
Included items		Instruction manual, Circulation hose (1.5m)×2, Wire hose clamp ×2			
		Cover			

⌘ 1 Performance based on operation at room temperature (23°C±5°C), 65%RH±20% humidity, using water as coolant medium, no external load.

⌘ 2 Coolant medium: 60% solution of ethylene glycol and water

⌘ 3 Coolant medium: tap water

⌘ 4 Value in brackets includes flow adjustment valve. All other protrusions excluded.

⌘ 5 Value in brackets is breaker (power switch) capacity.

11. WIRING DIAGRAM

CF301 Wiring Diagram

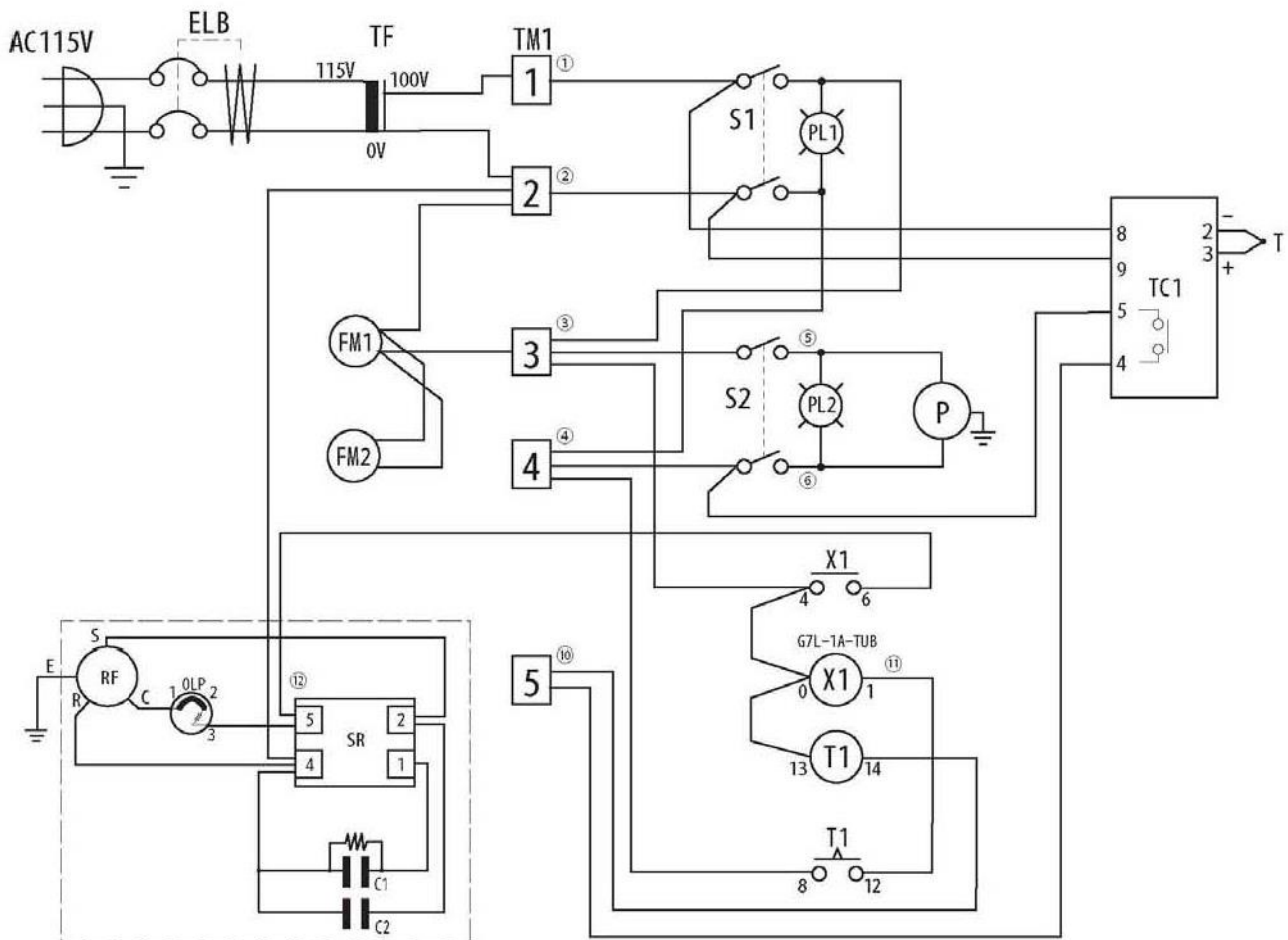

Symbol	Part name	Symbol	Part name
ELB	Earth leakage breaker	T1	Delay timer relay
TC1	Temperature controller	C1	Operation condenser
S1	Refrigeration switch	C2	Start condenser
S2	Pump switch	FM1/FM2	Fan motor
X1	Relay	RF	Refrigeration unit
P	Pump	TF	Transformer
TM1	Terminal	OLP	Over load protector

Replacement Items

	Item	Part No.	Specification No.	Manufacturer
1	Filter	CF30140200	CF301-40200	Yamato
2	Drain Cap	CF30140190	CF301-40190	Yamato
3	Overflow Cap	FE72T41000	FE72T-41000	Yamato

12. LIST OF HAZARDOUS SUBSTANCES



Never process any explosive, flammable samples and also samples contained with those substances.

Explosive Substance	① Nitroglycol, Glycerine trinitrate, Cellulose Nitrate and other explosive nitrate esters
	② Trinitrobenzen, Trinitrotoluene, Picric Acid and other explosive nitro compounds
	③ Acetyl Hydroperoxide, Methyl Ethyl Ketone Peroxide, Benzoyl Peroxide and other organic peroxides
	④ Metallic Azide, including Sodium Azide, etc.
Explosive Substances	① Metal "Lithium" ② Metal "Potassium" ③ Metal "Natrium" ④ Yellow Phosphorus
	⑤ Phosphorus Sulfide ⑥ Red Phosphorus ⑦ Phosphorus Sulfide
	⑧ Celluloids, Calcium Carbide (a.k.a, Carbide) ⑨ Lime Phosphide ⑩ Magnesium Powder
	⑪ Aluminum Powder ⑫ Metal Powder other than Magnesium and Aluminum Powder
	⑬ Sodium Dithionous Acid (a.k.a., Hydrosulphite)
Oxidizing Substances	① Potassium Chlorate, Sodium Chlorate, Ammonium Chlorate, and other chlorates
	② Potassium Perchlorate, Sodium Perchlorate, Ammonium Perchlorate, and other perchlorates
	③ Potassium Peroxide, Sodium Peroxide, Barium Peroxide, and other inorganic peroxides
	④ Potassium Nitrate, Sodium Nitrate, Ammonium Nitrate, and other nitrates
	⑤ Sodium Chlorite and other chlorites
	⑥ Calcium Hypochlorite and other hypochlorites
Flammable Substances	① Ethyl Ether, Gasoline, Acetaldehyde, Propylene Chloride, Carbon Disulfide, and other substances with ignition point at a degree 30 or more degrees below zero.
	② n-hexane, Ethylene Oxide, Acetone, Benzene, Methyl Ethyl Ketone and other substances with ignition point between 30 degrees below zero and less than zero.
	③ Methanol, Ethanol, Xylene, Pentyl n-acetate, (a.k.a. amyl n-acetate) and other substances with ignition point between zero and less than 30 degrees.
	④ Kerosene, Light Oil, Terebinth Oil, Isopenthyll Alcohol (a.k.a. Isoamyl Alcohol), Acetic Acid and other substances with ignition point between 30 degrees and less than 65 degrees.
Combustible Gas	Hydrogen, Acetylene, Ethylene, Methane, Ethane, Propane, Butane and other gases combustible at 15°C at one air pressure.

(Source: Appendix Table 1 of Article 6 of the Industrial Safety and Health Order in Japan)

Limited liability

Always operate equipment in strict compliance to the handling and operation procedures set forth by this instruction manual.

Yamato Scientific Co., Ltd. assumes no responsibility for malfunction, damage, injury or death resulting from negligent equipment use.

Never attempt to disassemble, repair or perform any procedure on CF301 unit which is not expressly mandated by this manual. Doing so may result in equipment malfunction, serious personal injury or death.

Notice

- ◆ Instruction manual descriptions and specifications are subject to change without notice.
- ◆ Yamato Scientific Co., Ltd. will replace flawed instruction manuals (pages missing, pages out of order, etc.) upon request.

Instruction Manual

**NeoCool Circulator
Model CF301**

Second Edition May 25, 2017

Revised:

Yamato Scientific America Inc.

925 Walsh Avenue, Santa Clara, CA 95050

Phone: 800.292.6286 / 408.235.7725

<http://www.yamato-usa.com>